

A High Performance Algorithm for EMG Signal Denoising With Classification Using Multilevel Dwt

Mangala Gowri S .G, Dr.Cyiril Prasanna Raj P

Abstract— Electromyography (EMG) is a technique for evaluating and recording the electrical activity produced by skeletal muscles. An electromyography detects the electrical potential generated by muscle cells when these cells are electrically or neurologically activated. The signals can be analyzed to detect medical abnormalities, activation level, or recruitment order or to analyze the biomechanics of human or animal movement. Wavelet Transform (WT) has been applied for removing noise from the surface EMG. Gaussianity tests are conducted to understand changes in muscle contraction and to quantify the effectiveness of the noise removal process. Wavelets are functions that satisfy certain mathematical requirements and are used in representing data or other functions. In this paper we analyze the performance of different level DWT for EMG signal denoising and compare the results considering mean square error (MSE). The Denoising analysis concludes using bior multi level wavelet and the mean was optimal in nature for different global threshold.

Index Terms— Electromyography signal, EMG, Wavelet transform, Signal Denoising

1 INTRODUCTION

The EMG signal is the electrical manifestation of the neuromuscular activation associated with a contracting muscle. It is an exceedingly complicated signal which is affected by the anatomical and physiological properties of muscles, the control scheme of the peripheral nervous system, as well as the characteristics of the instrumentation is used to detect and observe it. Detection of EMG signals with powerful and advance methodologies is becoming a very important requirement in biomedical engineering [2]. EMG signal processing is measured by using rms value of power of the signal. Electromyography (EMG) signals can be used for clinical/biomedical applications, Evolvable Hardware Chip (EHW) development, and modern human computer interaction. A comparison study is also given to show performance of various EMG signal analysis methods. This paper provides researchers a good understanding of EMG signal and its analysis procedures. This knowledge will help them develop more powerful, flexible, and efficient applications [1]. The capability of detecting Electromyography signals improved steadily from the 1930s through the 1950s and researchers began to use improved electrodes more widely for the study of muscles [12, 2]. EMG signal analysis to provide efficient and effective ways of understanding the signal and its nature. The EMG signal is a complicated signal, which is controlled by the nervous system. The nervous system always controls the muscle activity. EMG signals acquired from muscles require advanced methods for detection, decomposition, processing, and classification. EMG signal acquires noise while travelling through different tissues. Moreover, the EMG detector, particularly if it is at the surface of the skin, collects signals from different motor units at a time which may generate interaction of different Signals. Detection of EMG signals with powerful and advance methodologies is becoming a very important requirement. In biomedical engineering [3].

Basic Block Diagram

An EMG signal is acquired by the Electrodes placed on the patient body Electromyography (EMG) signal represents the electrical activity of muscles. A muscle is composed of Many Motor Units (MUs). EMG signals detected directly from the muscle or from the skin by using surface electrodes, respectfully, show a train of Motor Unit Action Potentials (MUAP) plus noise, the raw EMG signal shows an increase in the number of MUAP recruited at increasing firing rates, resulting in the Interference Pattern (IP). The firing pulses are normally considered a random function of time, which is non-Gaussian in nature. Quantitative analysis of the IP is useful in the diagnosis of neuromuscular disorders. In the past years, several computer-aided techniques for IP analysis have been proposed such as turns amplitude analysis, decomposition methods and power spectrum analysis. It is difficult to obtain high-quality electrical signals from EMG sources because the signals typically have low amplitude (in range of mV) and are easily corrupted by noise. The simplest way method of removing narrow bandwidth interference from recorded signal is to use a linear, recursive digital notch filter. But the disadvantage of the notch filter is that, it distorts the signal.

Pre-processing performs digitalization process and takes the samples to perform feature extraction. A feature extraction process is lengthy, it extracts all the features of EMG signal and performs classification of different standard wave by using DWT algorithm. By applying denoising algorithm using IDWT, the original signals are obtained. Wavelet denoising has wide range of application in signal processing as well as other fields. The signals may be one-dimensional, two-dimensional and three-dimensional. They carry useful information. Denoising (noise reduction) is the first step in many applications.[5]. EMG signal acquires noise while travelling through different tissues.

Moreover, the EMG detector particularly is at the surface of the skin, collects signals from different motor units at a time which may generate interaction of different signals.

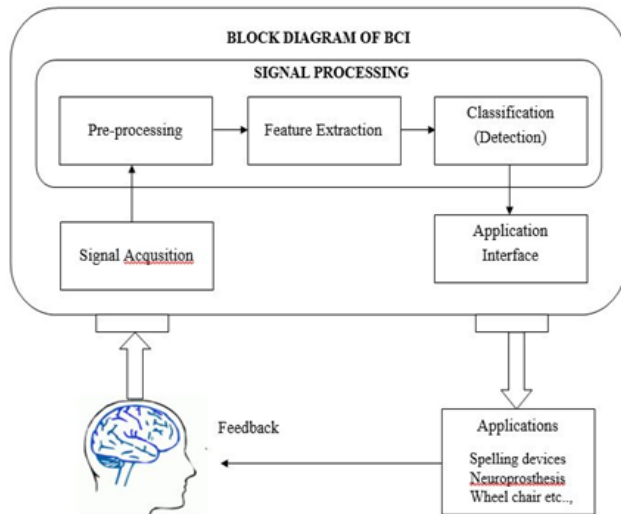

Fig1. Basic Block Diagram

2 ELECTROMYOGRAPHY

2.1 Characteristics of the EMG Signal

An Electromyogram (EMG) measures the electrical activity of muscles at rest and during contraction. Nerve conduction studies measure how well and how fast the nerves can send electrical signals. Nerves control the muscles in the body with electrical signals called impulses. These impulses make the muscles react in specific ways. Nerve and muscle problems cause the muscles to react in abnormal ways. If you have leg pain or numbness, you may have these tests to find out how much your nerves are being affected. These tests check how well your spinal cord, nerve roots, and nerves and muscles that control your legs are working. To acquire surface EMG (sEMG) signal, electrodes are placed on the skin overlying the muscle. Alternatively, wire or needle electrodes are used and these can be placed directly in the muscle [3]. When EMG is acquired from electrodes mounted directly on the skin, the signal is a composite of all the muscle fiber action potentials occurring in the muscle or muscles underlying the skin. Hence, the EMG signal is a complicated signal, which is controlled by the nervous system and is dependent on the anatomical and physiological properties of muscles.

The amplitude of the signal can range from 0 to 10 mV (peak-to-peak) or 0 to 1.5 mV (rms). The usable energy of the signal is limited to the 0 to 500 Hz frequency range, with the dominant energy being in the 50-150 Hz range [1]. Usable signals are those with energy above the electrical noise level. Various signal-processing methods are applied on raw EMG to achieve the accurate and actual EMG signal. The electrodes are the point of contact where the current that is produced by the electrical stimulation unit reaches the body. The design of the elec-

trode unit is the most critical aspect of the electronic apparatus, which will be used to obtain the signal. Clinical electromyography is a technique for diagnosing neuromuscular disorders by analyzing the electrical signal recorded from a contracting muscle using an electrode. The signal, called an electromyogram (EMG), is made up of trains of discrete wavelets called motor unit action potentials (MUAP's) which result from the repetitive discharges of a group of muscle fibers. During strong contractions, the MUAP's are so numerous that the EMG becomes a noise-like interference pattern. During weak contraction, few motor units are active. EMG signal from the brachial biceps muscle recorded using an electrode during moderate voluntary contraction. High-pass filtering makes the motor unit discharges more distinct.

Muscles are made up of slender fibers about 50 microns in diameter—about the same thickness as a human hair. These fibers are organized into groups known as motor units. All the fibers in a motor unit are innervated by a single motor neuron, and so they act together during a muscular contraction. The nervous system activates the motor unit by sending electrical impulses along the motor neuron axon. The contraction of skeletal muscle is initiated by impulses in the neurons to the muscle and is usually under voluntary control. Skeletal muscle fibers are well-supplied with neurons for its contraction. This particular type of neuron is called a "motor neuron". An electromyograph detects the potential generated by muscle cells. When these cells are electrically or neurologically activated. The signals can be analyzed to detect medical abnormalities, activation level, and recruitment order or to analyze the biomechanics of human or animal movement.

The neurons are the basic structural unit of the nervous system and vary considerably in size and shape. Neurons are highly specialized cells that conduct messages in the form of nerve impulses from one part of the body to another. A muscle is composed of bundles of specialized cells capable of contraction and relaxation. The primary function of these specialized cells is to generate forces, movements and the ability to communicate such as speech or writing or other modes of expression.

A potential difference exists between the intra-cellular and extracellular fluids of the cell. In response to a stimulus from the neuron, a muscle fiber depolarizes as the signal propagates along its surface and the fiber twitches. This depolarization, accompanied by a movement of ions, generates an electric field near each muscle fiber. An EMG signal is the train of Motor Unit Action Potential (MUAP) showing the muscle response to neural stimulation. The EMG signal appears random in nature.

Recorded EMG offers us valuable information in a particularly useless form. This information is useful only if it can be quantified. Various signal-processing methods are applied on raw EMG to achieve the accurate and actual EMG signal. The electrodes are the point of contact where the current that is produced by the electrical stimulation unit reaches the body. The design of the electrode unit is the most critical aspect of the electronics apparatus, which will be used to obtain the signal.

3 PROPOSED CLASSIFICATION ALGORITHM USING DWT FOR EMG SIGNAL

The aim of the project is to analysis and characterize the EMG signal and classify various sampled EMG signal with reference to standard brain continuous waves like alpha, beta, gamma etc by using the DWT (discrete wavelet transform). Brainwaves can be categorized according to their frequency:

3.1 Classification Overview

Gamma brainwaves (100 - 38 Hz) were detected later than the other brain waves, less is known about them so far. They have been seen in states of peak performance. A lot of research is currently being done on gamma brainwaves in the 40 Hz range during meditation. One of the characteristics of gamma waves is a synchronization of activity over wide areas of the brain. Gamma brainwaves are not easy to detect because of their low amplitude with amplitude of 3-5µV and can only be partly displayed on the Mind Mirror screen. Sometimes they may be seen as a narrow frequency band at 38 Hz.

Betas (38 - 15 Hz) are the brainwaves of our "normal" waking consciousness, of our outward attention, of logical, conscious and analytical thinking. High frequency beta ("splayed beta") is seen with restlessness, stress, anxiety, panic or whiles our inner critic or commentator is active. Splayed beta can be differentiated from the low frequency beta of the awakened mind, when thinking feels clear, alert, creative and to the point.

Alpha brainwaves (14 - 8 Hz) are seen when we are in a relaxed state, daydreaming or visualizing. We need alpha waves as the bridge to the lower frequencies to the subconscious (theta), if we want to remember the content of our dreams or our meditation, or if we want to retrieve information from our subconscious. For this reason alpha is especially important in combination with other brainwaves.

Theta (7 - 4 Hz) represents the subconscious. We see theta during dream sleep meditation, during peak experiences and creative states. In theta we find unconscious or suppressed parts of our psyche as well as our creativity and spirituality. Theta images are usually less distinct and colorful than alpha images, sometimes of a bluish color, but they often feel more profound and meaningful. As long as we only produce theta brainwaves, their content will stay inaccessible to our waking mind.

Delta brainwaves (3-0.5Hz) are the brainwaves of the lowest frequency and represent the unconscious. If we only produce delta we will find us in dreamless deep sleep, but we also see delta in various combinations with other brainwaves. They may then represent intuition, curiosity, a kind of radar, hunches or a "feeling" for situations and other people. Delta is often seen with people who work in therapeutic environments or professions and with people who have had traumatic experiences and have developed a "radar" for difficult situations.

3.2 Discrete wavelet Transform

The discrete wavelet transform (DWT) achieves this parsimony by restricting the variation in translation and scale, usually to powers of 2. The basic analytical expressions for the DWT will be presented here; however, the transform is easier to understand, and easier to implement using filter banks [4]. The DWT is often introduced in terms of its recovery transform: The DWT is often introduced in terms of its recovery transform:

$$x(t) = \sum_{k=-\infty}^{\infty} \sum_{l=-\infty}^{\infty} d(k,l) 2^{-l} \psi(2^{-k}t - l) \tag{1}$$

Here k is related to a as: $a = 2^k$; b is related to l as $b = 2^k l$; and $d(k,l)$ is a sampling of $W(a,b)$ at discrete points k and l .

In the DWT, a new concept is introduced termed the scaling function, a function that facilitates computation of the DWT. To implement the DWT efficiently, the finest resolution is computed first. The computation then proceeds to coarser resolutions, but rather than start over on the original waveform, the computation uses a smoothed version of the fine resolution waveform. This smoothed version is obtained with the help of the scaling function. In fact, the scaling function is sometimes referred to as the smoothing function. The definition of the scaling function uses dilation or a two-scale difference equation:

$$\phi(t) = \sum_{n=-\infty}^{\infty} \sqrt{2}c(n)\phi(2t-n) \tag{2}$$

Where $c(n)$ is a series of scalars that defines the specific scaling function. This equation involves two time scales (t and $2t$) and can be quite difficult to solve. In the DWT, the wavelet itself can be defined from the scaling function:

$$\psi(t) = \sum_{n=-\infty}^{\infty} \sqrt{2}d(n)\phi(2t-n) \tag{3}$$

where $d(n)$ is a series of scalars that are related to the waveform $x(t)$ and that defines the discrete wavelet in terms of the scaling function.

While the DWT can be implemented using the above equations, it is usually implemented using filter bank techniques. The DWT is computed by successive low pass and high pass filtering of the discrete time-domain signal as shown in Figure 2. This is called the Mallat algorithm or Mallat-tree decomposition. Its significance is in the manner it connects the continuous time multiresolution to discrete-time filters. In Figure 2, the signal is denoted by the sequence $x[n]$, where n is an integer. The low pass filter is denoted by G_0 while the high pass filter is denoted by H_0 . At each level, the high pass filter produces detail information of $d[n]$, while the low pass filter associated with scaling function produces coarse approximations, $a[n]$.

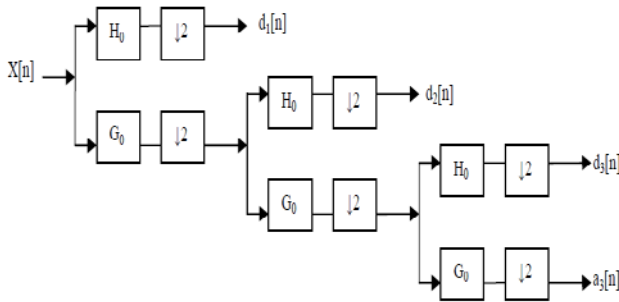

Fig.2 DWT decomposition tree

The Surface EMG (sEMG) signals was denoised using discrete wavelet transform (DWT) and a threshold method. The DWT and threshold based denoising was implemented using MATLABWavelet toolbox. Wavelets commonly used for denoising biomedical signals include the Daubechies (db2, db8, and db6) wavelets and orthogonal Meyer wavelet. The wavelets are generally chosen whose shapes are similar to those of the MUAP.

4 IMPLEMENTATION AND RESULTS

The denoising is a process to remove noise from acquired signal. Figure 3, shows how the noise is removed, and how the signal is classified. In the EMG signal block it consists of a set of EMG signals. A white Gaussian noise is added to it and DWT is applied up to 3rd level. Then apply IDWT to check whether the noise is completely removed or not. Calculate MSE, if MSE is approximately equal to zero then noise is removed. Hence compare with original signal, and then finally apply classification.

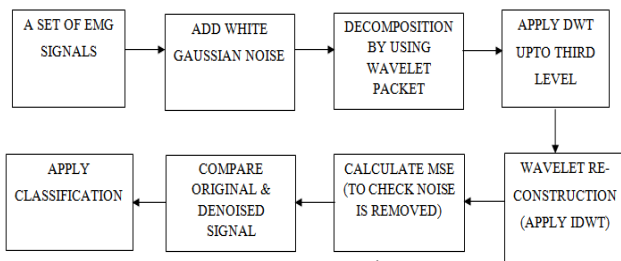

Fig.3 Proposed Block Diagram

The performance of four conventional denoising algorithms – namely rigrsure, heursure, sqtwolog’ and minimax is compared. The denoising procedure is explained in the flow chart shown in Figure 4. With the four methods, denoising is done. Type of thresholding used is soft thresholding. Denoised signal’s performance is compared based on mean square error computed. This is implemented using Matlab tool box, which is widely used for high performance numerical computation and visualization

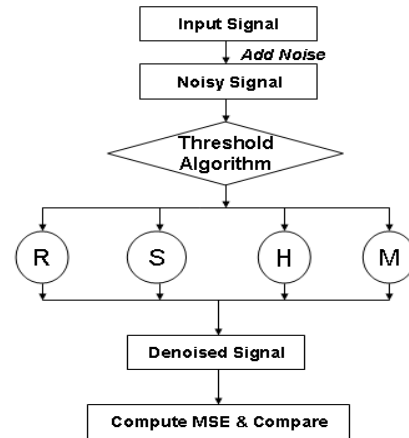

Fig. 4 Denoising Procedure [5]

The wavelet used is db4. Ingrid Daubechies invented what are called compactly supported orthonormal wavelets, thus making discrete wavelet analysis practicable. Daubechies wavelets are the most popular wavelets. They represent the foundations of wavelet signal processing and are used in numerous applications. The names of the Daubechies family wavelets are written dbN, where N is the order. The implementation task is shown in figure 5, in the following flowchart. Consider the EMG signal, add white Gaussian noise. Apply DWT up to N levels until the noise is completely removed.

4.1 Software Implementation



Fig. 5 Implementation of EMG Signal

Consider the EMG signal. Add white Gaussian noise, apply DWT up to N levels until the noise is completely removed. To check noise, compute MSE for each levels. Here for 3rd level the noise is approximately removed i.e. MSE=0. Now recover the signal by applying IDWT. Compare with the original signal.

In numerical analysis and functional analysis, a discrete wavelet transform (DWT) is any wavelet transform for which the wavelets are discretely sampled.

The DWT of a signal X is calculated by passing it through a series of filters. First the samples are passed through a low

pass filter with impulse response g resulting in a convolution of the two:

$$y[n] = (x * g)[n] = \sum_{k=-\infty}^{\infty} x[k]g[n - k].$$

The signal is also decomposed simultaneously using a high-pass filter h . The outputs giving the detail coefficients (from the high-pass filter) and approximation coefficients (from the low-pass). It is important that the two filters are related to each other and they are known as a quadrature mirror filter. However, since half the frequencies of the signal have now been removed, half the samples can be discarded according to Nyquist's rule. The filter outputs are then subsample by 2 that is Mallat's and the common notation is the opposite, g - high pass and h - low pass:

$$y_{low}[n] = \sum_{k=-\infty}^{\infty} x[k]h[2n - k]$$

This decomposition has halved the time resolution since only half of each filter output characterizes the signal. However, each output has half the frequency band of the input so the frequency resolution has been doubled.

4.2 Applying DWT for EMG Signal



Fig. 6 Group of Frames from EMG Signal

- Input EMG signal is divided into frames of 128 points each as shown in Figure 6 above.
- Each frame is passed through the multi level DWT to produce wavelet coefficients as shown in the Figure 7

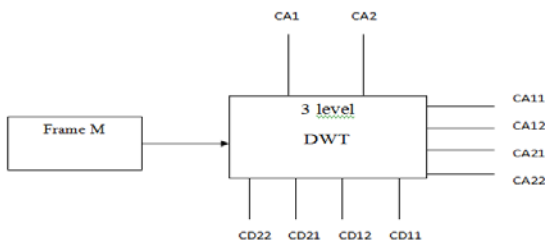

Fig.7 Block diagram of EMG signal multilevel DWT

3 level DWT flow chart of generating two coefficient each in every of their corresponding input to from 8 set of 4 approximated and 4 detailed coefficient is as shown in the Figure 8.

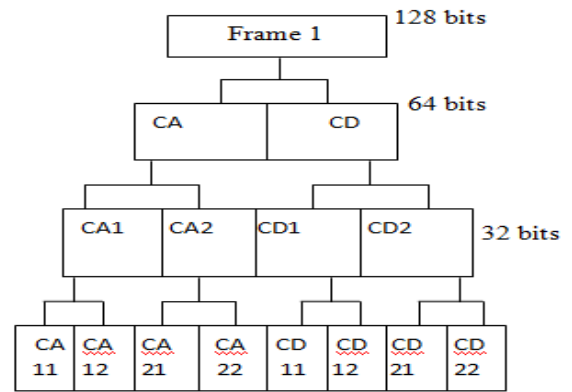

Fig.8 Multilevel DWT with coefficients for Frame M

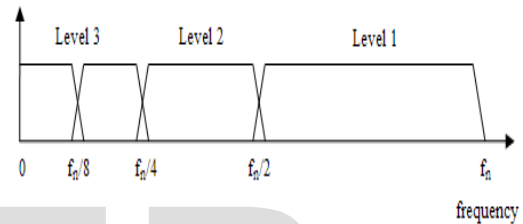

Fig.9 DWT Coefficient generation Flow graph with Frequency domain analysis.

- In level 1, the 128 bits frame values or transferred into 62 bit each into CA and CD.
- In level 2, the 62 bit CA and CD is down sampled to 32 bit each into CA1, CA2, CD1 and CD2.
- In level 3, each coefficient in level two is again down sampled to generate 8 coefficients as shown in the flow graph.

4.3 Inverse Discrete Wavelet Transform (IDWT)

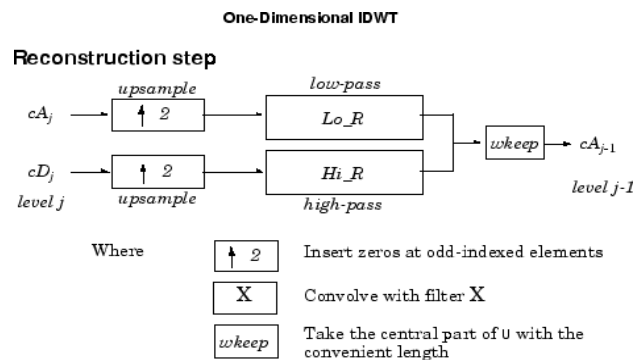

Fig.10 One dimensional IDWT

Given the coefficient sequence $S^{(M)}$ for some $M < J$ and all the difference sequences $d^{(k)}$, $k=M, \dots, J-1$, one computes recursively

$$s_n^{(k+1)} := \sum_{l=-N}^N a_k s_{2n-k}^{(k)} + \sum_{l=-N}^N b_k d_{2n-k}^{(k)}$$

OR

$$s^{(k+1)}(z) = a(z) \cdot (\uparrow 2)(s^{(k)}(z)) + b(z) \cdot (\uparrow 2)(d^{(k)}(z))$$

for $k=J-1, J-2, \dots, M$ and all $n \in \mathbb{Z}$.

In the Z-transform notation:

The upsampling operator $(\uparrow 2)$ creates zero-filled holes inside a given sequence. That is, every second element of the resulting sequence is an element of the given sequence, every other second element is zero

$$(\uparrow 2)(c(z)) := \sum_{n \in \mathbb{Z}} c_n z^{-2n}$$

or

This linear operator is, in the Hilbert space $\ell^2(\mathbb{Z}, \mathbb{R})$, the adjoint to the down sampling operator $(\downarrow 2)$.

4.4 Denoising algorithm

The Detailed and associated coefficients extracted in wavelet coefficients is as shown below.

- These coefficients are down sampled to in every level to give 32 bit data.
- Level 1 Coefficient is down sampled by 4 as shown in the figure 11 and 12.
- Level 2 Coefficients are down sampled by 2 to produce 32 bit data.
- The desampled coefficients are processed through energy calculation block.
- Energy Calculation block will do the summation of squared values of each bit of 32 bit input to it.
- Energy per Level is calculated and are summed together before processing to next summation.
- Energy calculated per level is summoned with energy value and is added with higher level values as shown in figure 11.
- Figure 11 and 12 shows an associated Coefficients energy value and detailed coefficients energy value respectively.
- Figure 13 constructs bounds of the input energy signal levels as shown in the figure.

To calculate and update the existing values to remove noise by calculating signal energy and cancelling the noise energy in the system.

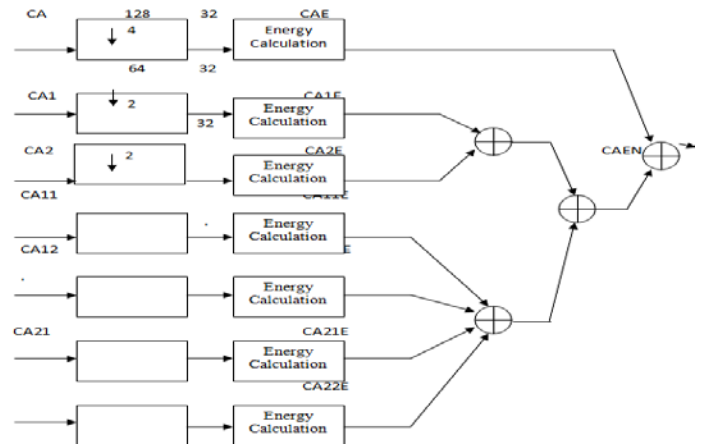

Fig.11 Denoising Block structure using Associated Coefficients

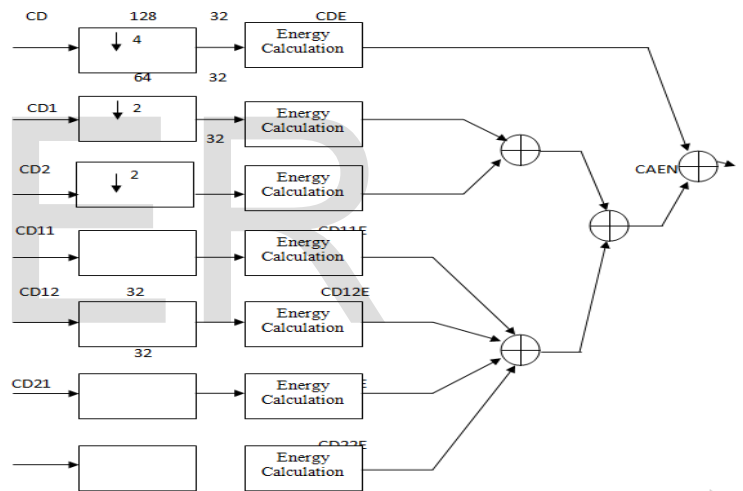

Fig.12 Denoising block structure using Detailed Coefficients

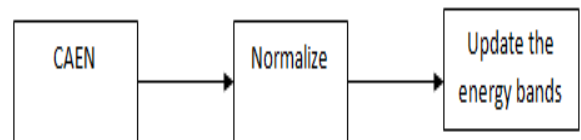

Fig. 13 Denoising block diagram using energy estimate

4.5 Comparison of wavelets

To find which level is better to remove noise and to select the better wavelet to filter noise, the trial and error method is done. The following table shows the comparison for a better wavelet

Table1
Comparison for better wavelet

Signals	For Bior 4.4 filter		For Haar filter		For dmeiy filter	
	With noise	Without noise	With noise	Without noise	With noise	Without noise
Synthetic 1	0.1000	0.0583x10 ⁻²¹	0.108	0.0673x10 ⁻²¹	0.9400	0.1059 x10 ⁻⁹
Synthetic 2	0.1003	0.0226 x10 ⁻²¹	0.0967	0.0372 x10 ⁻²¹	0.1030	0.0589 x10 ⁻⁹
Synthetic 3	0.1010	0.0149 x10 ⁻²¹	0.1037	0.0360 x10 ⁻²¹	0.1055	0.0862 x10 ⁻⁹
Synthetic 4	0.1022	0.0146 x10 ⁻²¹	0.1004	0.0239 x10 ⁻²¹	0.1041	0.1032 x10 ⁻⁹
Synthetic 5	0.0966	0.0348 x10 ⁻²¹	0.0954	0.0441 x10 ⁻²¹	0.1006	0.0383 x10 ⁻⁹
Synthetic 6	0.0997	0.0739 x10 ⁻²¹	0.1014	0.0859 x10 ⁻²¹	0.0979	0.0589 x10 ⁻⁹
Synthetic 7	0.1024	0.0151 x10 ⁻²¹	0.1003	0.0261 x10 ⁻²¹	0.1000	0.0862 x10 ⁻⁹
Synthetic 8	0.1033	0.0152 x10 ⁻²¹	0.1004	0.0295 x10 ⁻²¹	0.1009	0.1032 x10 ⁻⁹
Real 1	0.1029	0.0235 x10 ⁻²¹	0.1037	0.0313 x10 ⁻²¹	0.1011	0.0383 x10 ⁻⁹
Real 2	0.0973	0.0265 x10 ⁻²¹	0.0995	0.0360 x10 ⁻²¹	0.1103	0.2823 x10 ⁻⁹
Real 3	0.1010	0.0080 x10 ⁻²¹	0.1020	0.0139 x10 ⁻²¹	0.0995	0.0537 x10 ⁻⁹
Real 4	0.0992	0.0354 x10 ⁻²¹	0.1009	0.0456 x10 ⁻²¹	0.0976	0.1339 x10 ⁻⁹
Real 5	0.1001	0.1741 x10 ⁻²¹	0.0991	0.2652 x10 ⁻²¹	0.1030	0.6871 x10 ⁻⁹
Real 6	0.0997	0.1854 x10 ⁻²¹	0.1003	0.2742 x10 ⁻²¹	0.1005	0.7292 x10 ⁻⁹
Real 7	0.0996	0.1438 x10 ⁻²¹	0.1005	0.2347 x10 ⁻²¹	0.0999	0.5720 x10 ⁻⁹
Real 8	0.1008	0.0876 x10 ⁻²¹	0.0993	0.1956 x10 ⁻²¹	0.1004	0.9727 x10 ⁻⁹
Real 10	0.1005	0.0506 x10 ⁻²¹	0.1016	0.0714 x10 ⁻²¹	0.0979	0.2165 x10 ⁻⁹
Real 11	0.0996	0.1467 x10 ⁻²¹	0.0989	0.1556 x10 ⁻²¹	0.1046	0.0538 x10 ⁻⁹

4.6 Snapshot of Signals with noise

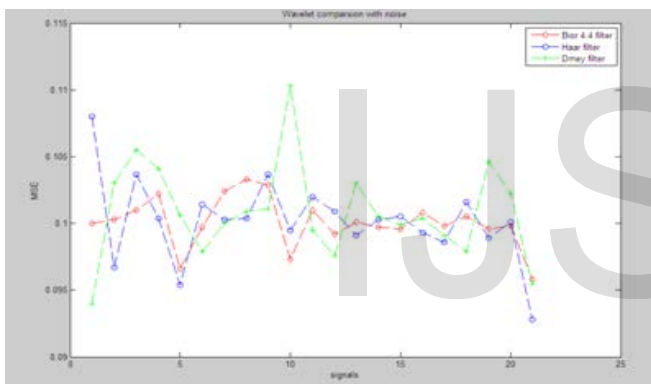

Fig. 14a Comparison of MSE for signal with noise
From Figure 14a, we can conclude that Bior 4.4 filter represented in red color has a optimized MSE value for all set of signals compared to Haar filter which has much variation for different signals and Dmey filter has higher MSE for more signals.

4.7 Snapshot of Signals without noise

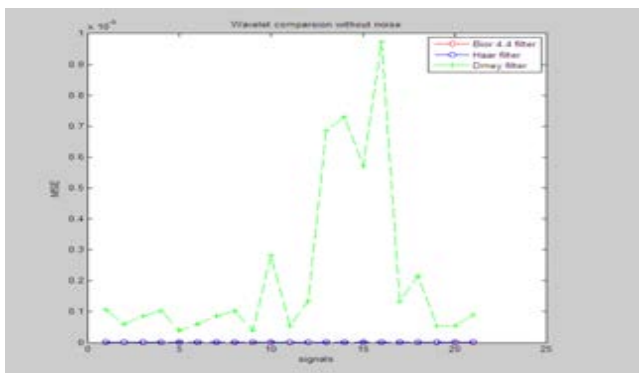

Fig. 14b Comparison of wavelets without noise

From Figure 14b, the comparison shows that Dmey filter has MSE of higher values compared to other two wavelets which are almost equal to zero. Through result analysis we can conclude that in the condition without noise both bior 4.4 and Haar filter provides better MSE compared to Dmey filter.

4.8 Comparison of wavelets for level 2

Results for level 2 (CB22=CB21=CB12=CB11=0)

Synthetic 1	0.1000	0.0583 x10 ⁻²¹	0.108	0.0673 x10 ⁻²¹	0.9400	0.1059 x10 ⁻⁹
Synthetic 2	0.1003	0.0226 x10 ⁻²¹	0.0967	0.0372 x10 ⁻²¹	0.1030	0.0589 x10 ⁻⁹
Synthetic 3	0.1010	0.0149 x10 ⁻²¹	0.1037	0.0360 x10 ⁻²¹	0.1055	0.0862 x10 ⁻⁹
Synthetic 4	0.1022	0.0146 x10 ⁻²¹	0.1004	0.0239 x10 ⁻²¹	0.1041	0.1032 x10 ⁻⁹
Synthetic 5	0.0966	0.0348 x10 ⁻²¹	0.0954	0.0441 x10 ⁻²¹	0.1006	0.0383 x10 ⁻⁹
Synthetic 6	0.0997	0.0739 x10 ⁻²¹	0.1014	0.0859 x10 ⁻²¹	0.0979	0.0589 x10 ⁻⁹
Synthetic 7	0.1024	0.0151 x10 ⁻²¹	0.1003	0.0261 x10 ⁻²¹	0.1000	0.0862 x10 ⁻⁹
Synthetic 8	0.1033	0.0152 x10 ⁻²¹	0.1004	0.0295 x10 ⁻²¹	0.1009	0.1032 x10 ⁻⁹
Real 1	0.1029	0.0235 x10 ⁻²¹	0.1037	0.0313 x10 ⁻²¹	0.1011	0.0383 x10 ⁻⁹
Real 2	0.0973	0.0265 x10 ⁻²¹	0.0995	0.0360 x10 ⁻²¹	0.1103	0.2823 x10 ⁻⁹
Real 3	0.1010	0.0080 x10 ⁻²¹	0.1020	0.0139 x10 ⁻²¹	0.0995	0.0537 x10 ⁻⁹
Real 4	0.0992	0.0354 x10 ⁻²¹	0.1009	0.0456 x10 ⁻²¹	0.0976	0.1339 x10 ⁻⁹
Real 5	0.1001	0.1741 x10 ⁻²¹	0.0991	0.2652 x10 ⁻²¹	0.1030	0.6871 x10 ⁻⁹
Real 6	0.0997	0.1854 x10 ⁻²¹	0.1003	0.2742 x10 ⁻²¹	0.1005	0.7292 x10 ⁻⁹
Real 7	0.0996	0.1438 x10 ⁻²¹	0.1005	0.2347 x10 ⁻²¹	0.0999	0.5720 x10 ⁻⁹
Real 8	0.1008	0.0876 x10 ⁻²¹	0.0993	0.1956 x10 ⁻²¹	0.1004	0.9727 x10 ⁻⁹
Real 10	0.1005	0.0506 x10 ⁻²¹	0.1016	0.0714 x10 ⁻²¹	0.0979	0.2165 x10 ⁻⁹
Real 11	0.0996	0.1467 x10 ⁻²¹	0.0989	0.1556 x10 ⁻²¹	0.1046	0.0538 x10 ⁻⁹
Real 12	0.0998	0.2468 x10 ⁻²¹	0.1001	0.2591 x10 ⁻²¹	0.1022	0.0338 x10 ⁻⁹

Here the CB22, CB21, CB12 & CB11 frame samples is multiplied by zero and applies IDWT. MSE is calculated and results are as shown in above table.

4.9 Comparison of wavelets for level 3

Results for level 3 (CB22=CB21=CB12=CB11=CA22=CA21=0)

Signals	With noise	Without noise
Synthetic 1	0.1006	0.00057 x10 ⁻²⁷
Synthetic 2	0.0965	0.1526 x10 ⁻²⁷
Synthetic 3	0.0938	0.0069 x10 ⁻²⁷
Synthetic 4	0.1021	0.0044 x10 ⁻²⁷
Synthetic 5	0.0969	0.1762 x10 ⁻²⁷
Synthetic 6	0.1072	0.0026 x10 ⁻²⁷
Synthetic 7	0.0921	0.0016 x10 ⁻²⁷
Synthetic 8	0.1017	0.0125 x10 ⁻²⁷
Real 1	0.0963	0.0075 x10 ⁻²⁷
Real 2	0.0965	0.0076 x10 ⁻²⁷
Real 3	0.1702	0.0072 x10 ⁻²⁷
Real 4	0.1010	0.0050 x10 ⁻²⁷
Real 5	0.1672	0.0176 x10 ⁻²⁷
Real 6	0.1923	0.0352 x10 ⁻²⁷
Real 7	0.0956	0.0036 x10 ⁻²⁷
Real 8	0.0921	0.1246 x10 ⁻²⁷
Real 9	0.0960	0.0081 x10 ⁻²⁷
Real 10	0.1029	0.0001 x10 ⁻²⁷
Real 11	0.0958	0.0153 x10 ⁻²⁷
Real 12	0.1062	0.0001 x10 ⁻²⁷
Real 13	0.0955	0.0023 x10 ⁻²⁷

Here the CB22, CB21, CB12, CB11, CA22, CA21 & CA12 frame samples is multiplied by zero and IDWT is applied. MSE is calculated and results are as shown in the following figure

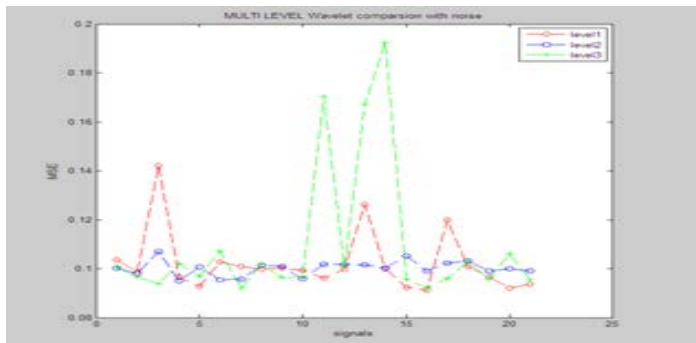

Fig.14c Multi-Level based wavelet comparison with noise.

Observation of the graph concludes that higher the level, lower is the MSE for most of the signal types but exceptions are there for two or three signals. By comparing the above results, we can conclude that 'Bior4.4' wavelet is best filter for remove noise and to implement in FPGA, But 'Haar' filter is also a best wavelet but it is not suitable for implementation in FPGA.

4.10 Classification Results

The below shown result is after denoising the MSE value and also the result of classification of each frame by calculating the energy of each frame. It can be concluded that 'Bior' wavelet is the best filter for noise removal of EMG signal

MEAN = 0.1008

RESULT = 122.3642 21.2085 24.8349 23.4977 21.8785 21.6955 23.4108

Signal Values	Condition	Brain Waves
122.3642	PERSON IS IN SLEEP OR COMMA	Gamma
21.2085	PERS ON IS IN MENTAL IMAGINARY	Beta
24.8349	PERS ON IS IN MENTAL IMAGINARY	Beta
23.4977	PERS ON IS IN MENTAL IMAGINARY	Beta
21.8785	PERS ON IS IN MENTAL IMAGINARY	Beta
21.6955	PERS ON IS IN MENTAL IMAGINARY	Beta
23.4108	PERS ON IS IN MENTAL IMAGINARY	Beta

5. CONCLUSION AND FUTURE WORK

This paper has provided an overview of what HMI has to offer, and has shown you a glimpse of what the future might hold. One thing that is certain is that technologies will begin to converge, devices will combine functionality to enhance our Human Machine Interaction. The technology involved in HMI is quite incredible. Brain computer interfaces have opened up a spectrum of assistive technologies, which are particularly appropriate for people with traumatic brain-injury, especially those who suffer from "locked-in" syndrome.

Hence the denoising using bior wavelet is emerging, promising, and proved to be a valuable for noise removal of EMG signal. In the near future we will see higher function prosthetics, brain computer interfaces with more control, voice recognition and camera gesture recognition being used more. Although not quite the death of the everyday mouse and keyboard, we will definitely start to see new types of technology integrated into our everyday lives. Portable devices are becoming smaller and more complex, so we should start seeing

growth in wearable interfaces. Robots, and the way we interact with them is already beginning to change, we are in the computer era, but soon we will be in the robotic era.

6. REFERENCES

- [1] M. B. I. Reaz, M. S. Hussain and F. Mohd-Yasin, Biol. Proced.2006"Techniques of EMG signal analysis: detection, processing, classification and applications", 8(1):11-35.
- [2] Kaplanis, P.A., C.S. Pattichis, L.J. Hadjileontiadis and S.M. Panas, 2000. "Bi-spectral analysis of surface EMG". 10th Mediterranean Electrotechnical Conference, Cyprus, 2: 770-773.
- [3] Akash Kumar Bhoi, Jitendra Singh Tamang, Purnendu Mishra, 2012"Wavelet packet based Denoising of EMG Signal "International Journal of Engineering Research and Development Volume 4, Issue 2, 78-83
- [4] N. M. Sobahi, 2011 "Denoising of EMG Signals Based on Wavelet Transform" Asian Transactions on Engineering Volume 01, Issue 05 2011
- [5] Jeena Joy, Salice Peter, Neetha John ,2013 "Denoising Using Soft Thresholding" International Journal of Advanced Research in Electrical, Electronics and Instrumentation Engineering, Vol. 2, Issue 3.
- [6] Kumar DK, Pah ND, 2003 "Wavelet analysis of surface electromyography to determine muscle fatigue." IEEE Trans Neural Syst Rehabil Eng. 11(4):400-6.
- [7] Ali Hussein Ali, Al-Timemy Nebras Hussein, Ghaeb Taha Yassin Khalaf, 2008 "Wavelet Neural Network Based Emg Signal Classifier" ISSUE vol.11, No.1, pp 137-144.
- [8] Merlo A, Farina D., 2003 "A Fast and Reliable Technique for Muscle Activity Detection from Surface EMG Signals." IEEE Trans Biomed Eng.; 50(3):316-323. Jeng-Ren Duann, Tzyy-Ping Jung, Scott Makeig "Brain Signal Analysis".
- [9] Geeta kaushik, Dr. H.P.Sinha, Dr. Lillie Dewan "Biomedical Signals Analysis by DWT Signal Denoising with Neural Networks" Journal of Theoretical and Applied Information Technology 10th April 2014. Vol. 62 No.1
- [10] P. Johankhani, V. Kodogiannis, and K. Revett. 2006. "EEG Signal Classification Using Wavelet Feature Extraction and Neural Networks". IEEE Int. Symp. on Modern Computing, pp 120-124.
- [11] Shahid S. "Higher Order Statistics Techniques Applied to EMG Signal Analysis and Characterization." Ph.D. thesis, University of Limerick; Ireland, 2004.
- [12] Lindström LH, Magnusson RI (1977) Interpretation of myoelectric power spectra: a model and its applications. Proceedings of the IEEE 65: 653-662